

MDL-III-1300-SLD-SM/1~10mW

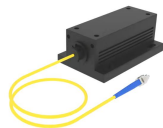

**INFRARED DIODE LASER
AT 1300nm**

It features a wide spectral linewidth, short coherent length, long lifetime and easy operation. They are widely used in medical treatment, machine vision, metrology, fiber optic current sensing, etc.



SPECIFICATIONS

Central wavelength (nm)	1300±20	
Spectral linewidth (nm)	~40	
Operating mode	CW	
Output power after fiber (mW)	>1,2,3,..., 10	
Power stability (rms, over 4 hours)	<3%, <2%, <1%, <0.5%	
Fiber type	SM fiber	
Fiber Core Diameter(μm)	4~9	
Fiber NA	0.12	
Fiber Connector	FC/PC, FC/APC	
Fiber Length (m)	1 (Other lengths are available on request)	
Transverse mode	TEM ₀₀	
Ellipticity	>0.95	
M ² factor after fiber	~1.1	
Warm-up time (minutes)	<5	
Operating temperature (°C)	10~35	
Power supply	85-264VAC	PSU-III-LED/ PSU-III-FDA (Frequency for 1Hz-30kHz)
	100-240VAC	PSU-A-D (Frequency for 30kHz -100kHz)
Modulation optional	TTL on/off, 1Hz-1kHz, 1kHz-10kHz, 10kHz-30kHz, 30kHz-100kHz; and Analog modulation optional	
Expected lifetime (hours)	10000	
Warranty	1 year	

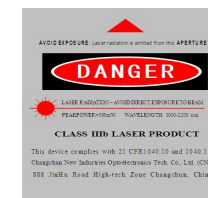

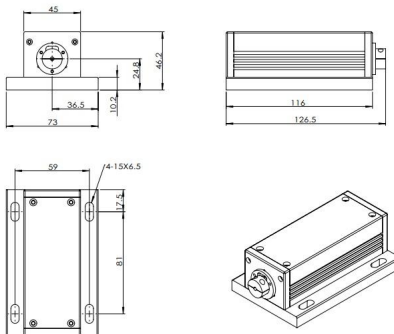
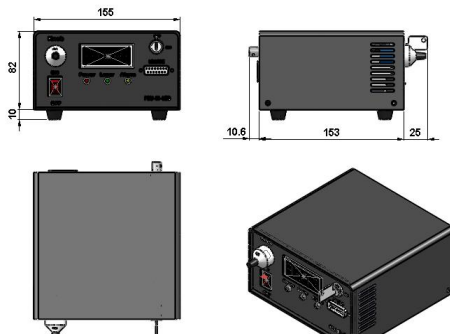
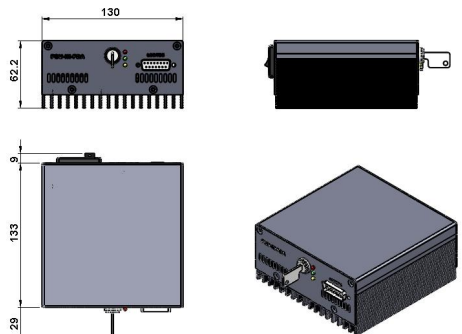
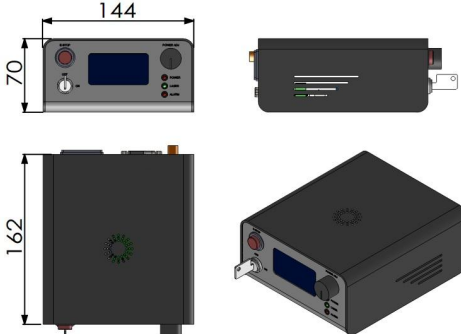
MDL-III-1300-SLD-SM	PSU-III-LED	PSU-III-FDA	PSU-A-D
 <p>126.5(L) × 73(W) × 46.2(H) mm³, 0.7kg</p>	 <p>188.6 (L) × 155(W) × 92 (H) mm³, 1.5kg</p>	 <p>171(L) × 130(W) × 62.2 (H) mm³, 1.2kg</p>	 <p>162(L) × 144(W) × 70 (H) mm³, 1.0kg</p>