

MDL-III-1560DFB-SM/1~15mW



**INFRARED DIODE LASER
AT 1560nm**

It features ultra compact design, long lifetime, cost-effectiveness and easy operation. They are used in measurement, communication, spectrum analysis, etc.



SPECIFICATIONS

Central wavelength (nm)	1560±3	
Operating mode	CW	
Output power after fiber (mW)	>1, 2, 3, ..., 15	
Power stability (rms, over 4 hours)	<3%, <2%, <1%, <0.5%	
Fiber type	SM fiber (PM fiber optional)	
Fiber Core Diameter(μm)	4~9	
Fiber NA	0.12	
Fiber Connector	FC/PC, FC/APC	
Fiber Length (m)	1 (Other lengths are available on request)	
Transverse mode	TEM ₀₀	
Ellipticity	>0.95	
M ² factor after fiber	~1.1	
Warm-up time (minutes)	<5	
Operating temperature (°C)	10~35	
Power supply	85-264VAC	PSU-III-LED/ PSU-III-FDA (Frequency for 1Hz-30kHz)
	100-240VAC	PSU-A-D (Frequency for 30kHz -100kHz)
Modulation optional	TTL on/off, 1Hz-1kHz, 1kHz-10kHz, 10kHz-30kHz, 30kHz-100kHz; and Analog modulation optional	
Expected lifetime (hours)	10000	
Warranty	1 year	

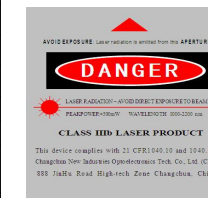

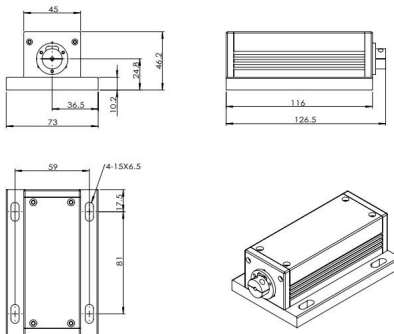
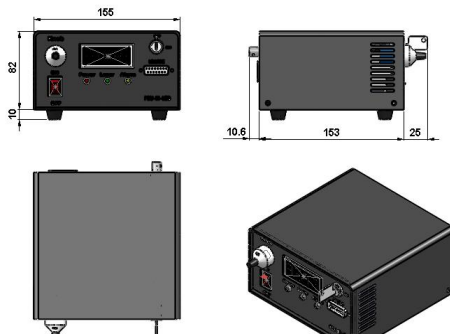
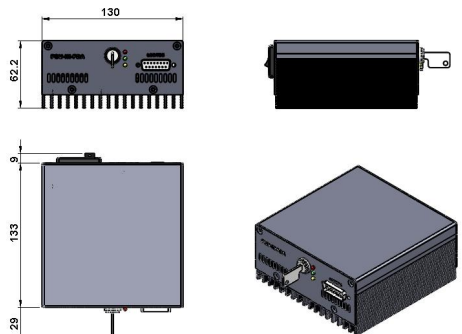
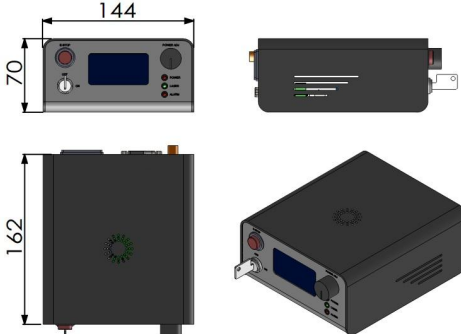
MDL-III-1560DFB-SM	PSU-III-LED	PSU-III-FDA	PSU-A-D
 <p>126.5(L) × 73(W) × 46.2(H) mm³, 0.7kg</p>	 <p>188.6 (L) × 155(W) × 92 (H) mm³, 1.5kg</p>	 <p>171(L) × 130(W) × 62.2 (H) mm³, 1.2kg</p>	 <p>162(L) × 144(W) × 70 (H) mm³, 1.0kg</p>