



AO-X-1064/1~670μJ/1~20W

**LD PUMPED ALL-SOLID-STATE
AOM Q-SWITCHED LASER
AT 1064 nm**

All solid state AOM Q-switched laser at 1064 nm has the features of high peak power, high repetition rate, and short pulse duration, which is widely used in marking, carving, measure, research and so on.



SPECIFICATIONS

Wavelength (nm)	1064±1
Operating mode	Acousto-Optic Q-switched
Average power (W)	1~20W (20W@30kHz) Average power (W) = Single pulse energy (mJ) * Rep. rate (kHz)
Single pulse energy (μJ)	1~670 (670μJ @30kHz)
Rep. rate (kHz)	10~100
Pulse duration (ns)	~20 @30kHz
Peak power (kW)	1~33 (33kW@30kHz)
Ave power stability (over 4 hours)	<3%, <5%
Warm-up time (minutes)	<10
Beam divergence, full angle (mrad)	<2
Beam diameter at the aperture (1/e2,mm)	~2.0
M ² factor	<1.5
Beam height from base plate (mm)	44
Cooled method	Air cooled
Operating temperature (°C)	10~35
Power supply (220/110VAC)	PSU-AOM(3U)
Expected lifetime (hours)	10000
Warranty period	1 year
Pilot light (optional)	~5mW @650nm

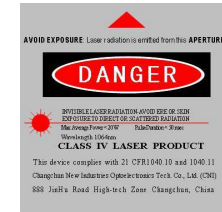

AO-X-1064

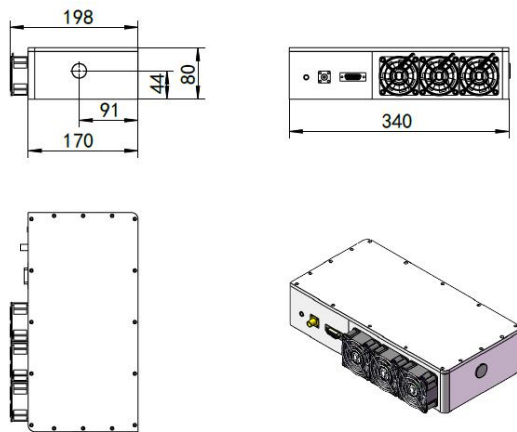

340 (L) × 198(W) × 80 (H) mm³, 15kg

PSU-AOM (3U)

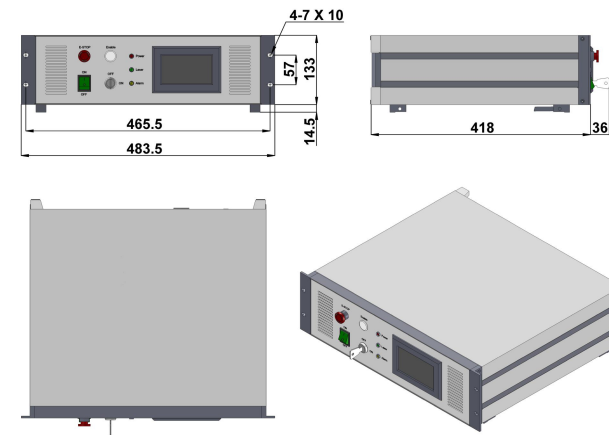

483.5 (L) × 454 (W) × 147.5 (H) mm³, 8.3 kg