



GLP-1342/0.6~5mW

**INFRARED LASER POINTER
AT 1342nm**



Infrared lasers are not commonly found amongst consumer electronic gadgets and have only recently been made available as IR laser pointers. Its beam is invisible.

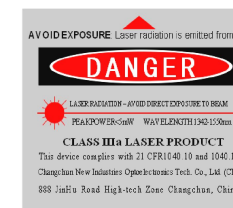

SPECIFICATIONS

Wavelength (nm)	1342±1		
Operating mode	CW		
Output power (mW)	0.6~1	1~3	3~5
Transverse mode	TEM ₀₀		
Beam diameter at the aperture (1/e ² , mm)	~1.5		
Beam divergence, full angle (mrad)	<1.5		
Switch	Push button		
Surface color	Black		
Power Consumption	DC 3V		
Power supply	2×AAA 1.5V Alkaline batteries		
Expected lifetime (hours)	5000		
Warranty	6 months		
Remark	LED indicator, key switch and logo engraving are on request.		

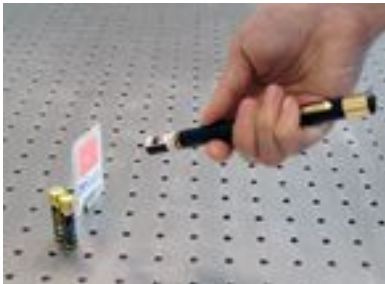
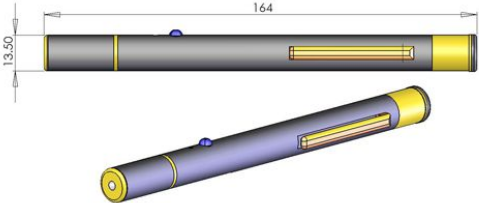

GLP-1342	Dimensions	Accessory
 <p>Φ13.5×164(L) mm³, 0.06 kg</p>		 <p>2×AAA/1.5V batteries</p>