

MDL-III-465/1~800mW



**BLUE DIODE LASER
AT 465nm**



It features ultra compact design, long lifetime, cost-effectiveness and easy operation. They are widely used in laser projection, stage lighting, biomedical applications, metrology, etc.



SPECIFICATIONS

Central wavelength (nm)	465±5	
Operating mode	CW	
Output power (mW)	>1,100,...,500	>500,600,...,800
Power stability (rms, over 4 hours)	<1%, <2%, <3% (<0.5%, optional)	
Transverse mode	Multimode	
Beam diameter at the aperture ((1/e ² ,mm)	<2.5×5.2	<2×5
Beam divergence, full angle (mrad)	<2.1×1.6	<2.5×0.2
Warm-up time (minutes)	<5	
Beam height from base plate (mm)	24.8	
Operating temperature (°C)	10~35	
Power supply	85-264VAC	PSU-III-LED/ PSU-III-FDA (Frequency for 1Hz-30kHz)
	100-240VAC	PSU-A-D (Frequency for 30kHz -100kHz)
TTL / Analog modulation	TTL or Analog with 1Hz-1kHz 1kHz-10kHz, 10kHz-30kHz, 30kHz-100kHz optional	
Expected lifetime (hours)	10000	
Warranty	1 year	

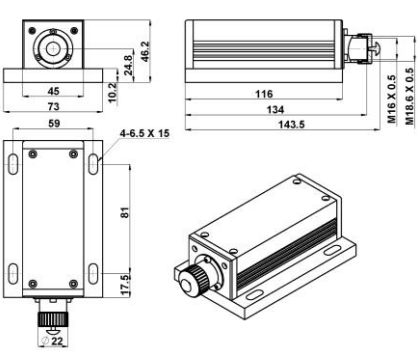
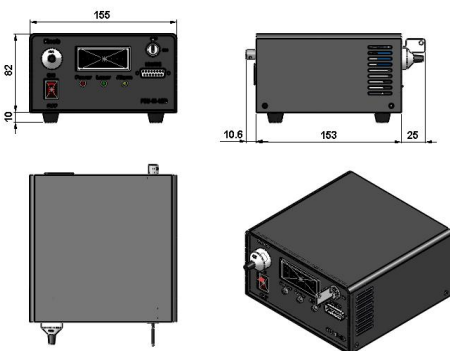
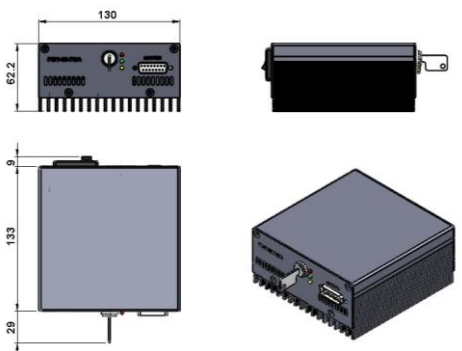

MDL-III-465	PSU-III-LED	PSU-III-FDA	PSU-A-D
 <p>143.5(L)×73(W)×46.2(H) mm³, 0.7kg</p>	 <p>188.6 (L) ×155(W) ×92 (H) mm³, 1.5kg</p>	 <p>171(L) ×130(W) ×62.2 (H) mm³, 1.2kg</p>	 <p>162(L) ×144(W) ×70 (H) mm³, 1.0kg</p>