

MPL-III-523.5/1~10uJ/1-50mW



LD PUMPED ALL-SOLID-STATE Q-SWITCHED LASER AT 523.5

All solid state Q-switched laser at 523.5 nm has the features of high peak power, high repetition rate, and short pulse duration, which is widely used in medical, scientific research, industry, etc.



SPECIFICATIONS

Central wavelength (nm)	523.5 ± 1	
Operating mode	Frequency conversion of Q-switched pulsed laser	
Single pulse energy (μJ)	1~10	
Pulse duration (ns)	~15	
Peak power (W)	70~700	
Rep. rate (kHz)	FIXED	Setting up one fixed rep. rate internal between 1kHz-4kHz with stable pulse energy, pulse duration and pulse period.
	EXT TRIG	1kHz-4kHz by external trigger with stable pulse energy, pulse duration and pulse period.
	QCW	QCW state with one rep. rate between 4kHz-5kHz.
Average power (mW)	Average power (mW) = Single pulse energy (μJ) * Rep. rate (kHz)	
Ave power stability (over 4 hours)	<3%, <5%,	
Transverse mode	TEM ₀₀	
Warm-up time (minutes)	<10	
M ² factor	<1.2	
Beam divergence, full angle (mrad)	<1.5	
Beam diameter at 1/e ² (mm)	~1.2	
Beam height from base plate (mm)	24.8	
Operating temperature (°C)	10~35	
Power supply (90-264VAC)	PSU-III-FDA	
Expected lifetime (hours)	10000	
Warranty period	1 year	



MPL-III-523.5

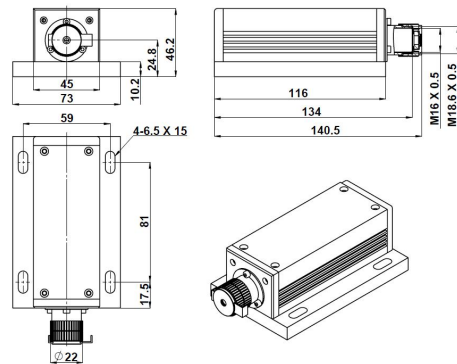

140.5 (L) × 73 (W) × 46.2 (H) mm³, 0.6kg

PSU-III-FDA

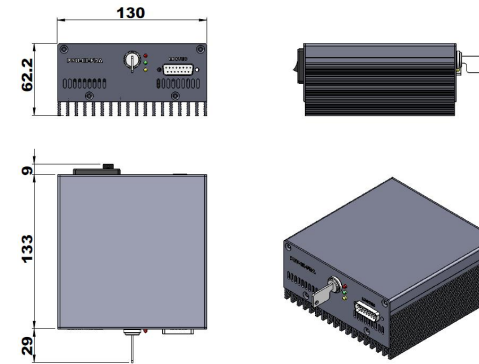

171 (L) × 130(W) × 62.2 (H) mm³, 1.2kg