

MPL-Q -290/1~50mW

**LD PUMPED ALL-SOLID-STATE Q-SWITCHED UV LASER at 290nm**

CNI's All solid state Q-switched UV laser at 290nm has the features of ultra compact, easy operating, it is widely used in UV curing, micro-electronics, metrology and material processing ,laser medical treatment, scientific experiment, etc



SPECIFICATIONS

Central wavelength (nm)	290±2
Operating mode	Acousto-Optic Q-switched
Average power (mW)	1-50
Rep. rate (kHz)	10
Pulse duration (ns)	10±2
Single pulse energy (μJ)	1~5
Peak power(W)	500W@10kHz@50mW
Beam diameter at the aperture (1/e <sup>2</sup> , mm)	Elliptical (1:2), Beam spot1.5*3mm;
Beam divergence, full angle (mrad)	<1
Power stability (rms, over 4 hours)	<3%, <5%,
Beam height from base plate (mm)	76.2
Warm-up time (minutes)	<10
Cooled method	Air Cooled
Power supply	PSU-AOM
Expected lifetime (hours)	10000
Warranty period	1 year

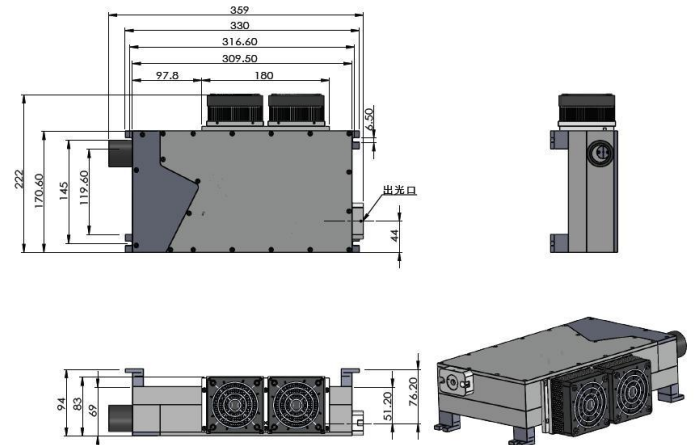
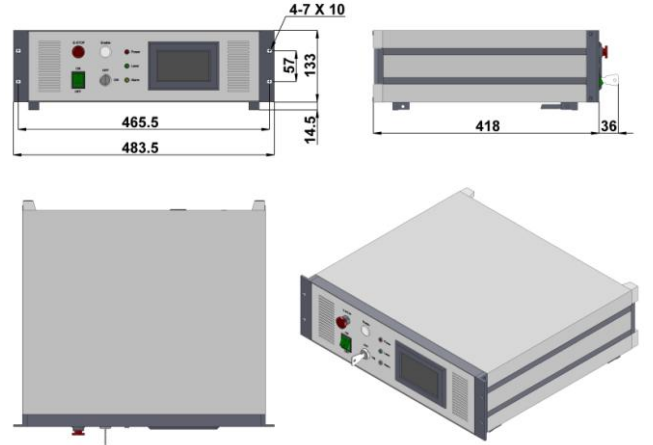

MPL-Q-290	PSU-AOM
 <p>359 (L) ×222 (W) ×94 (H) mm<sup>3</sup></p>	 <p>483.5 (L) ×454 (W) ×147.5 (H) mm<sup>3</sup>, 8.3 kg</p>