



PGL-D8-640/1~50mW

HIGH POWER RED LASER MODULE AT 640nm

Diode red laser 640nm is made features of ultra compact, long lifetime, low cost and easy operating, which is widely used in measurement, spectrum analysis, laser lighting show, etc.



SPECIFICATIONS

Wavelength (nm)	640±5
Operating mode	CW
Output power (mW)	>1,5, 10 , ... , 50
Transverse mode	Near TEM ₀₀
Beam diameter at the aperture (1/e ² , mm)	~3.5
Beam divergence, full angle (mrad)	<1.0
Operating temperature (°C)	15~30
Power supply	DC 3V PCB
Expected lifetime (hours)	10000
Warranty	6 months

Note: The shell has non-polarity.

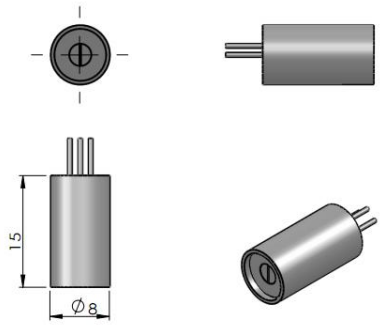
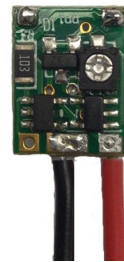

PGL-D8-640	Dimensions	3VPCB
 <p>Φ8×15(L) mm², 1.5g</p>		 <p>13(L) ×101(W) mm²</p>