



SLDP-1064-5-SM

■ Features

- 1064nm
- With 6um SM Fiber
- Coaxial or B2 Package
- Built-in PD



■ Absolute Maximum Ratings

Parameter	Symbol	Value	Unit
Reverse Voltage	Vr	2.0	V
Operating Temperature	Top	-10 ~ +50	°C
Storage Temperature	Tstg	-40 ~ +85	°C
Lead Soldering Temperature (10sec)	Tis	250	°C

■ Initial Electrical/Optical Characteristics

Item	Symbol
Center Wavelength @ 25°C	1064±5nm
Output Power	5mW
Fiber Type	SM Fiber
Fiber Core	6um
Monitor Current	0.3mA
PD Reverse Voltage	30V
Recommend Operating Temperature	25°C
Fiber Connector	FC/SC/SMA905
Fiber Length	80cm
Threshold Current (Typ.)	15mA
Operating Current (Typ.)	100mA
Operating Voltage	1.5V
Package Style	Coaxial or B2
Photodiodes	Built-in

CHANGCHUN NEW INDUSTRIES
OPTOELECTRONICS TECH.CO.,LTD.

CHANGCHUN NEW INDUSTRIES
OPTOELECTRONICS TECH.CO.,LTD.



electronics Tech. Co., Ltd ◆ CONTACT

No.888, Jinhua Road, High-tech Zone, Changchun
130103, China

Phone: +86-431-87033597

Fax: +86-431-87033597

Coaxial Package View

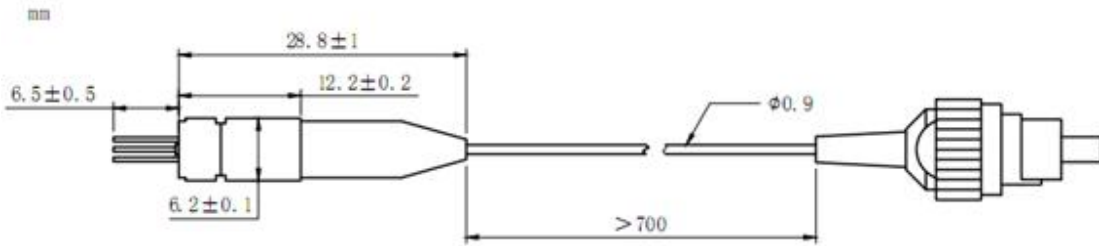

B2 Package View

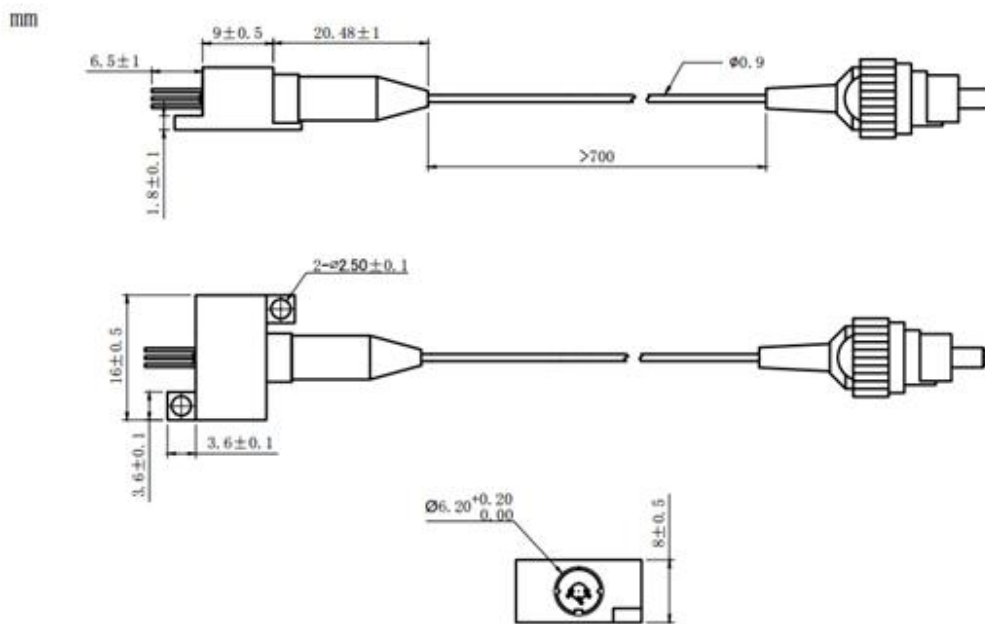

PIN Bottom View

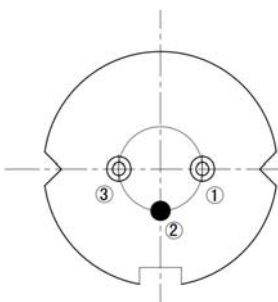

1	LD(-)
2	LD(+)&PD(-)
3	PD(+)



Changchun New Industries Optoelectronics Tech. Co., Ltd
<http://www.cnilaser.com>

◆ CONTACT

No.888, Jinhu Road, High-tech Zone, Changchun
 130103, China

Phone: +86-431-87033597

Fax: +86-431-87033597