

FC-OEM-976-B/1-1000mW



**VIOLET DIODE LASER
AT 976nm**

It features ultra compact design, long lifetime, cost-effectiveness and easy operation. They are used in medical imaging, flow cytometry, DNA sequencing, etc.



SPECIFICATIONS

Central wavelength (nm)	976±0.5
Spectral line width (nm)	<0.2, (<0.1 optional)
Operating mode	CW
Output power after fiber (mW) ¹	1-1000
Power stability (rms, 4 hours ± 3°C)	<2%, <1%, <0.5%
Fiber type	MM fiber
Fiber Core diameter	105µm, 0.22NA
Fiber connector	SMA905, FC/PC optional
Fiber length	0.8m
Fiber jacket	0.9mm PVC
Warm-up time (minutes)	<5
Cooled method	Conduction
Operating temperature (°C)	10-35
Operating voltage (VDC)	5V
Expected lifetime (hours)	>10000

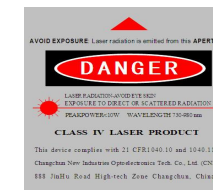

LASER HEAD (DRIVER Integrated)²

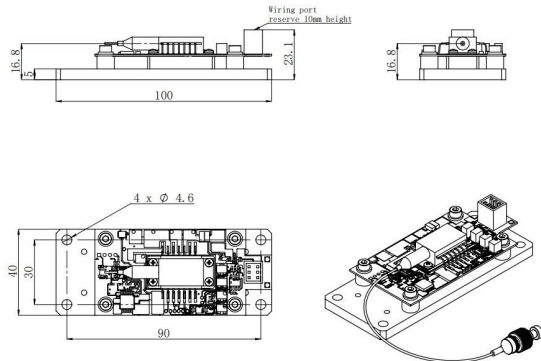

100 (L) × 40 (W) × 23.1 (H) mm³, 0.2kg

POWER SUPPLY (100-240VAC) optional

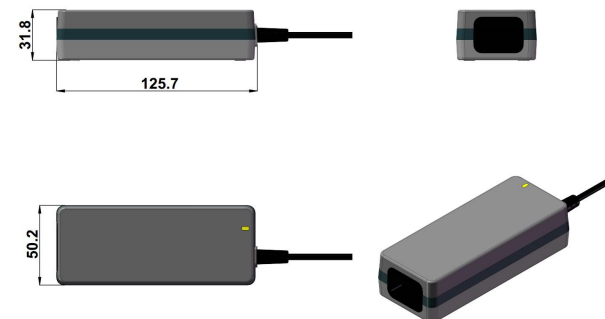

125.7 (L) × 50.2 (W) × 31.8 (H) mm³, 0.3kg

1 Any power level can be selected in this range.

2 Fixed output power; RS232 control optional;