

FC-W-445H-II/ 50~200W

BLUE DIODE LASER AT 445nm

Blue diode laser 445 nm is made features of ultra compact, long lifetime, low cost and easy operating. It's easy to be installed in customer's equipment.



SPECIFICATIONS

Wavelength (nm)	445±5
Operating mode	CW
Output power (W) @ after 400um fiber	50~200 (Higher power can be customized.)
Cooled method	Water cooled
Fiber Core Diameter (um)	200, 400, 600...
Fiber Connector	SMA905/ FC/ QBH
Numerical Aperture (NA)	0.22
Power stability (rms, over 4 hours)	<1%, <3%...
Warm-up time (minutes)	<5
Beam height from base plate (mm)	99
Operating temperature (°C)	25+/- -3
Power supply	90-264VAC
Modulation option	TTL/ Analog 1Hz-30KHz, TTL on/ off
Expected lifetime (hours)	10000



FC-W-445H-II (Water cooled)

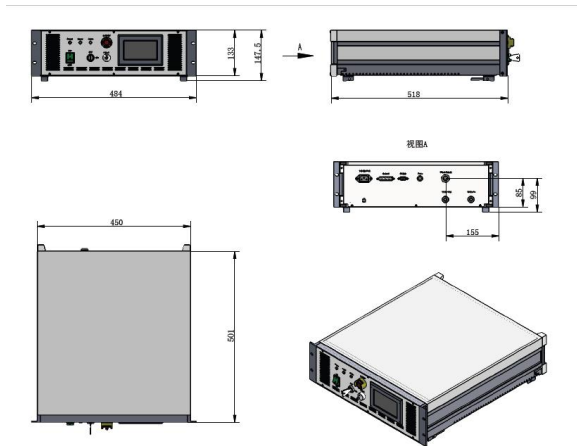

518 (L)×450(W)×147.5(H)mm<sup>3</sup>,

Water Chiller (WCH-370) (Optional)

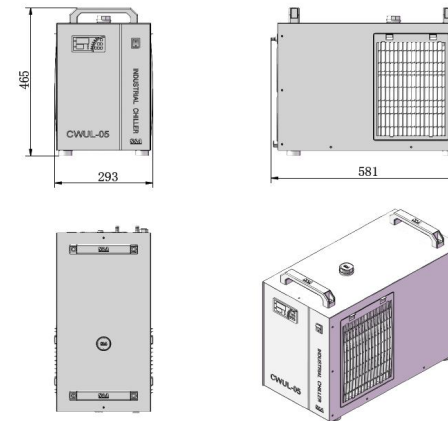

581(L)×293(W)×465(H)mm<sup>3</sup>,