

MDL-E-975/1-30mW

SPECIFICATIONS



**NARROW LINEWIDTH
DIODE LASER AT 975nm**

It features a narrow spectral linewidth, stable wavelength, long lifetime and easy operation. They are widely used in precision measurement, high resolution spectrum analysis, etc.



Central wavelength (nm)	975±5
Spectral line width (nm)	<0.06, <0.03
Operating mode	CW
Output power (mW) ¹	1-30
Power stability (rms, 4 hours ± 3°C)	<3%, <2%, <1%
Frequency shift (pm) (over ±2°C and 2hrs)	<20
Transverse mode	Near TEM ₀₀
M ²	<1.5
Beam diameter at the aperture (1/e ² , mm)	~3.5
Beam divergence, full angle (mrad)	<1.0
Polarization ratio	>50:1, (>100:1 optional) Horizontal±5 degree (Vertical optional)
Warm-up time (minutes)	<5
Cooled method	Conduction
Beam height from base plate (mm)	30
Operating temperature (°C)	20-30
Power supply (100-240VAC)	PSU-A-D
Expected lifetime (hours)	>10000

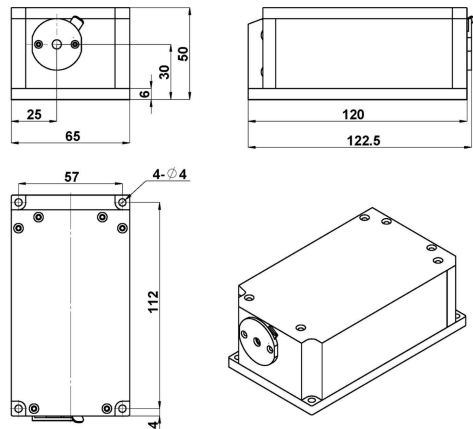
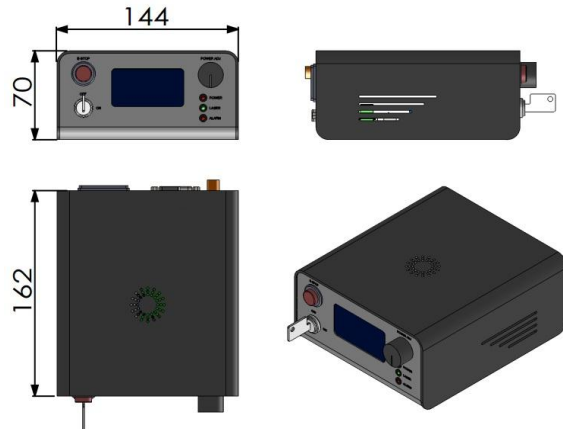

LASER HEAD	POWER SUPPLY ²
 <p>122.5 (L) × 65 (W) × 50 (H) mm³, 1.0kg</p>	 <p>162 (L) × 144 (W) × 70 (H) mm³, 1.0kg</p>

1 Any power level can be selected in this range.

2 Output power adjustable 10-100%; RS232 control optional.