

MDL-XS-405/1~200mW



DIODE XS SERIES LASER
AT 405nm

It features integrated electronics, plug and play, miniaturization, international standard interface. They are the ideal solution for a wide range of applications including life sciences, environmental monitoring, inspection and machine vision.



SPECIFICATIONS

Central wavelength (nm)	405±5
Operating mode	CW
Output power (mW)	>1, 10, 20, ...,200
Power stability (rms, over 4 hours)	<1%, <2%, <3%
Transverse mode	Near TEM ₀₀
Noise of amplitude(rms,20Hz~20MHz)	<1%(<0.5%, optional)
M ² factor	<1.2
Beam diameter at the aperture (1/e ² ,mm)	~1.2
Beam divergence, full angle (mrad)	<1.0
Polarization ratio	>50:1 (>100:1, optional) Horizontal±5 degree (Vertical Optional)
Warm-up time (minutes)	<5
Beam height from base plate (mm)	19
Operating temperature (°C)	10~35
Operating voltage	DC12V 4A
Modulation	DMOD (TTL) up to 1MHz
	AMOD (Analog) up to 100kHz
	DMOD+ AMOD (TTL + Analog)
Expected lifetime (hours)	10000
Warranty	1 year

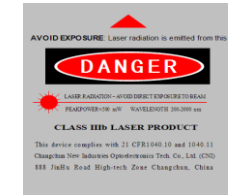

Note: The laser head needs to be used on a heat sink with good heat dissipation.

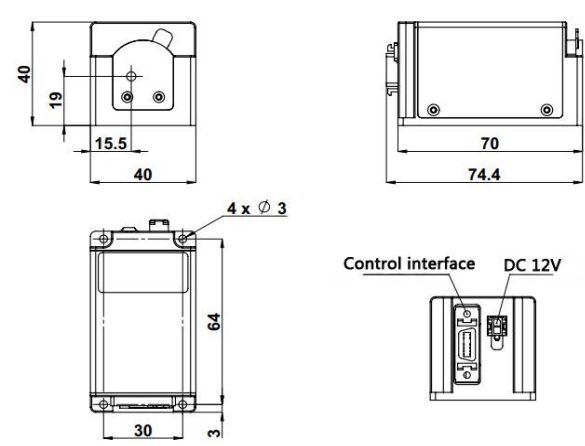
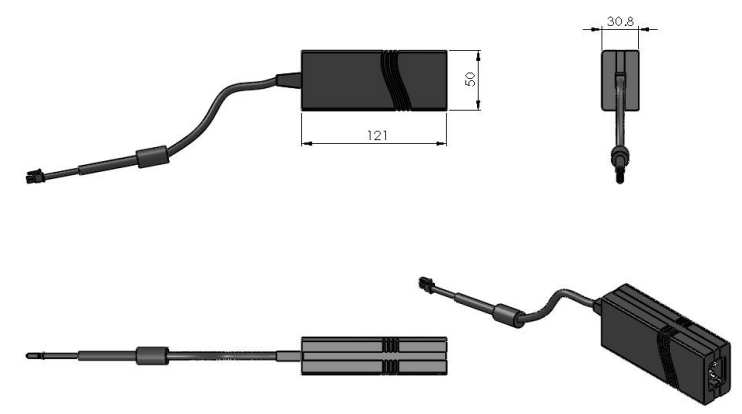
MDL-XS-405	Optional Power Supply (100-240VAC)
 <p>74.4(L) ×40(W) ×40 (H) mm³, 0.2kg</p>	 <p>121(L) ×50(W) ×30.8 (H) mm³, 0.3kg</p>