

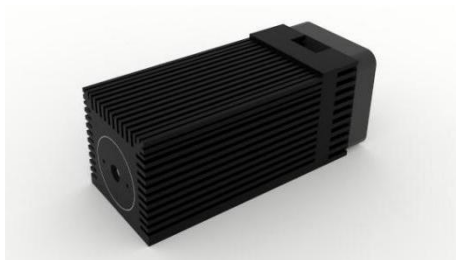

中国长春新产业光电技术有限公司
Changchun New Industries Optoelectronics Tech. Co., Ltd

PGL-V-H-808



Diode infrared laser module at 808nm is made features of ultra compact, long lifetime, low cost and easy operating, which made it be used widely in measurement, communication and spectrum analysis, etc.

SYSTEM SPECIFICATIONS*

Wavelength	nm	808	
Wavelength tolerance	nm	±10	
Output power	mW	1-100	1-2000
Power stability(rms, over 4 hours)		<5%, <3%, <1%	
Operating mode		CW	
Transverse mode		Near TEM ₀₀	Multimode
Beam diameter at the aperture(1/e ²)	mm	~4.5	~4*6
Beam divergence, full angle	mrad	<1	<5
Warm-up time	minutes	<10	
Beam height from base plate	mm	15	
Expected lifetime	hours	10000	
Warranty	years	1	

ELECTRICAL SPECIFICATIONS

Operating voltage(PSU-V-OEM)	100-240VAC
Operating voltage(PSU-I-OEM)	12VDC
Modulation optional	TTL30kHz and Analog 0-5V
Connection	9 pin connector

ENVIRONMENTAL CONDITIONS

Operating temperature	-10°C to 50°C
Storage temperature	-20°C to 80°C
Humidity	< 90%, non-condensing

MECHANICAL SPECIFICATIONS

Dimensions of laser head	92(L)×40(W)×40(H)mm ³
Material	Aluminum

*All testing data under the conditions of temperature 25°C.



Dimensions of laser head(92×40×40mm³)

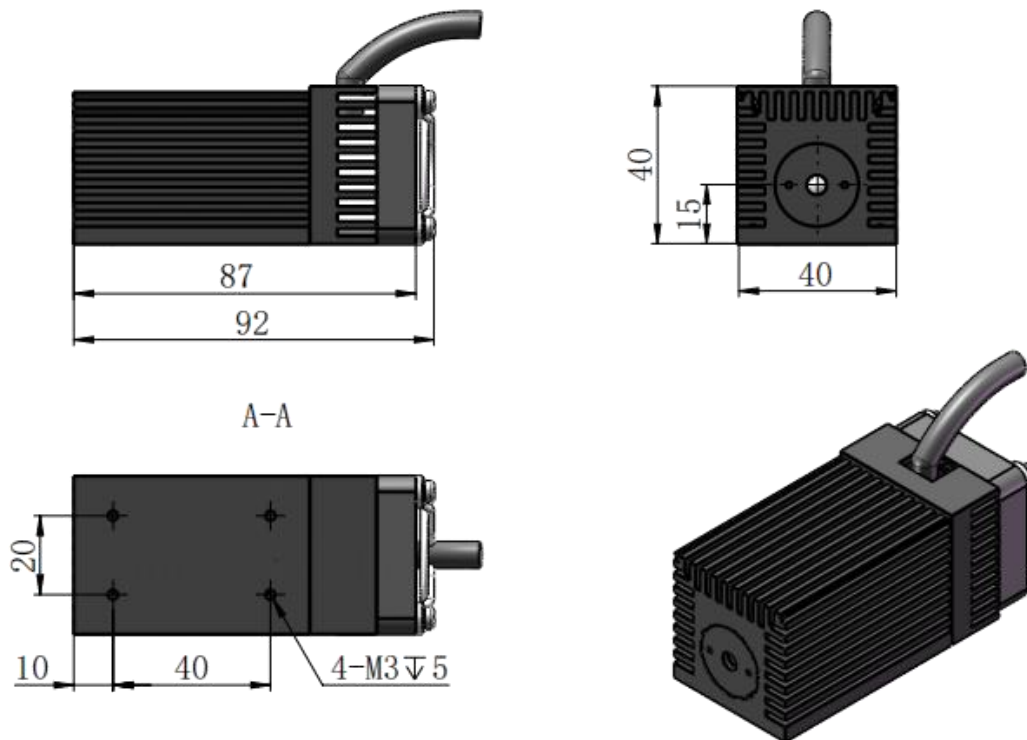

Dimensions of PSU-V-OEM power supply
(107×47×39mm³, 100-240VAC, TTL 30kHz and Analog 0-5V)

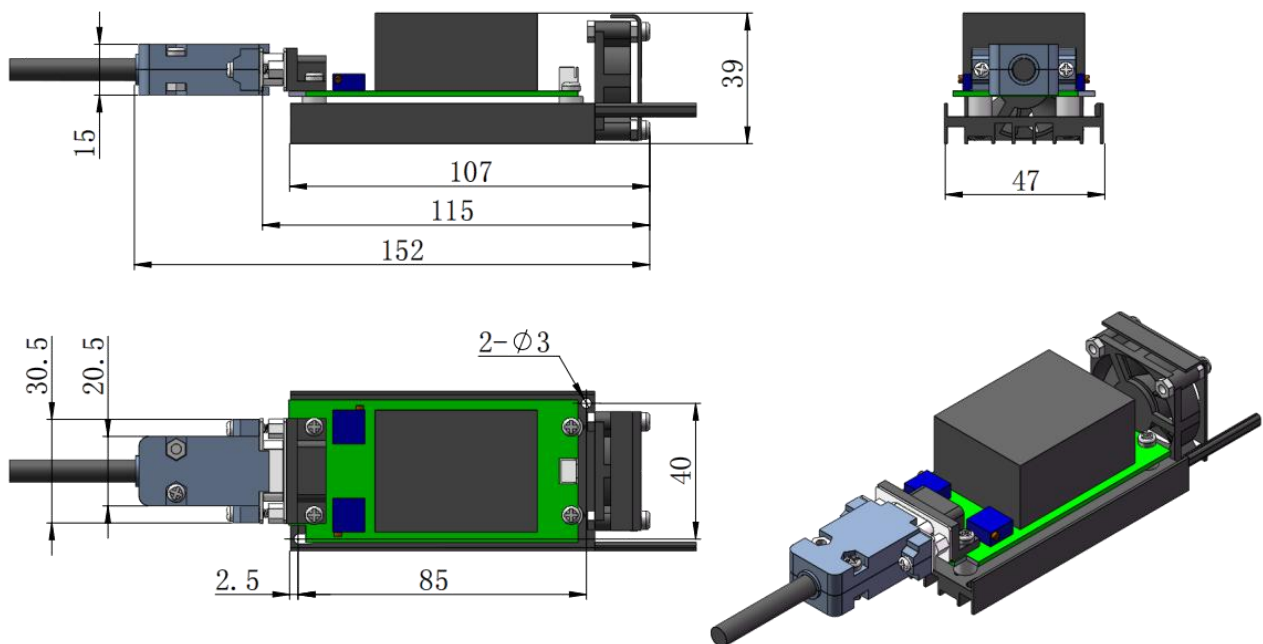



中国长春新产业光电技术有限公司
Changchun New Industries Optoelectronics Tech. Co., Ltd

Dimensions of PSU-I-OEM power supply(107×47×38mm³, 5/12VDC, TTL 30kHz and Analog 0-5V)

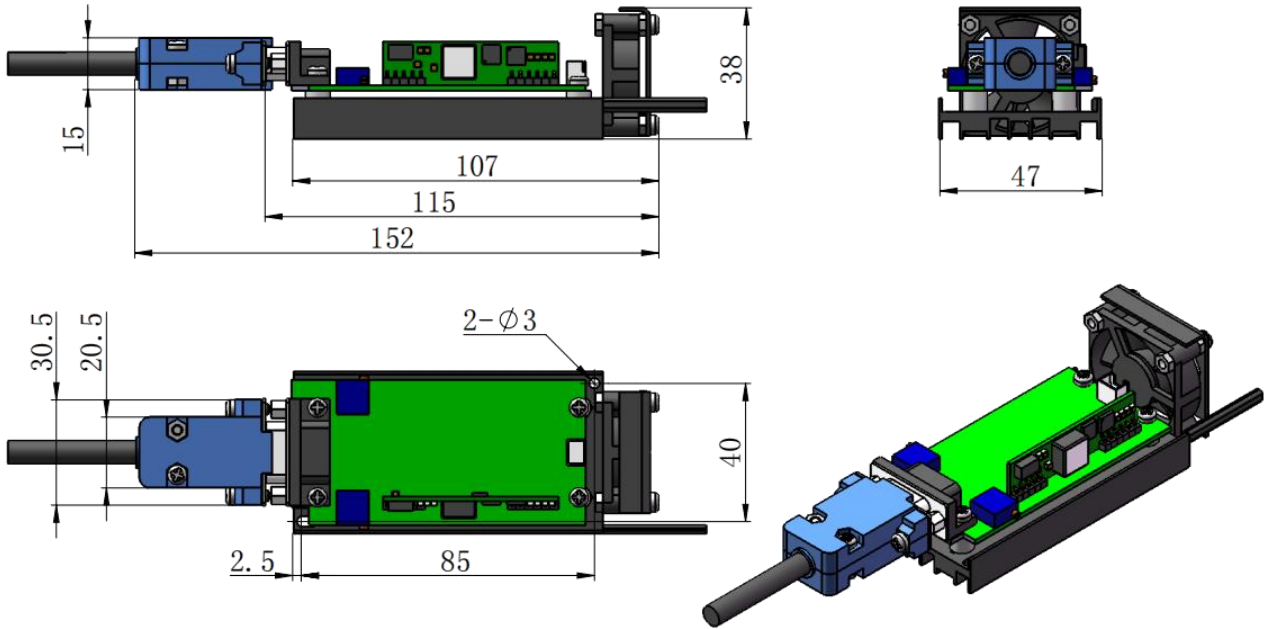

Dimensions of PSU-V-OEM and PSU-I-OEM power supply with dust cover(110×70×47mm³)

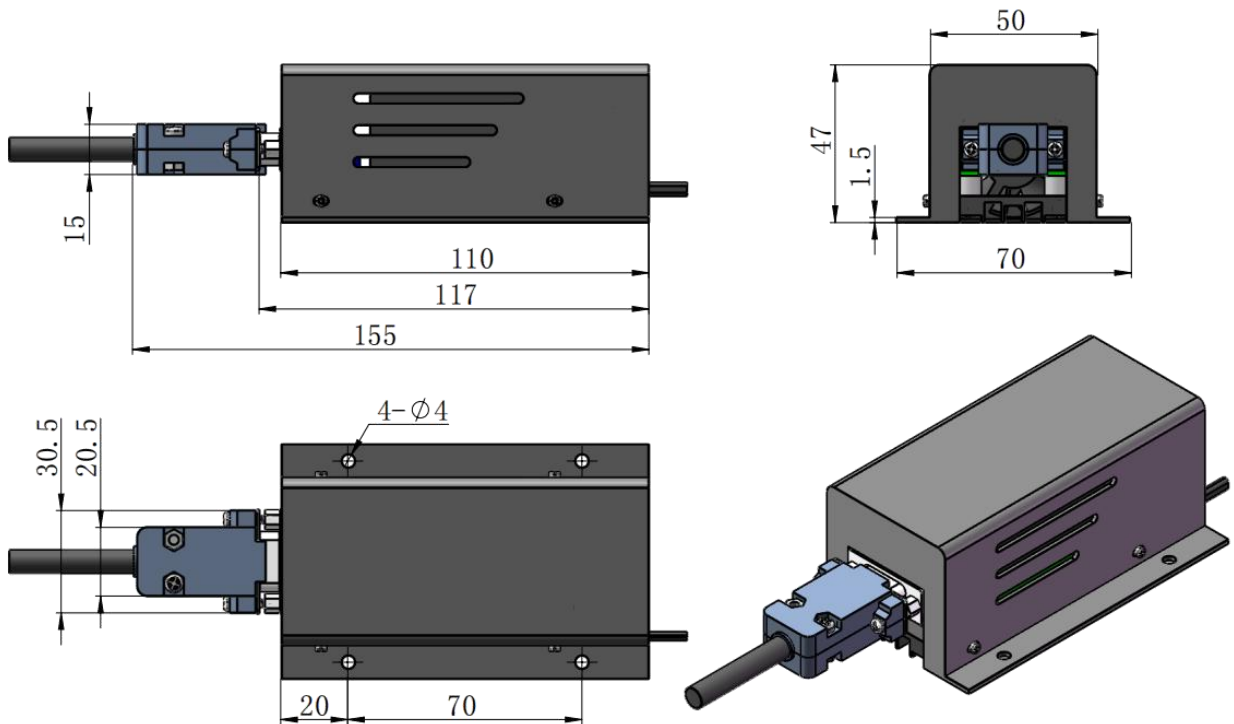



中国长春新产业光电技术有限公司
Changchun New Industries Optoelectronics Tech. Co., Ltd

Dimensions of PSU-V-OEM and PSU-I-OEM power supply with adjustable knob(110×70×84mm³)

